

6011-2RS1

SKF Explorer

Dimensions

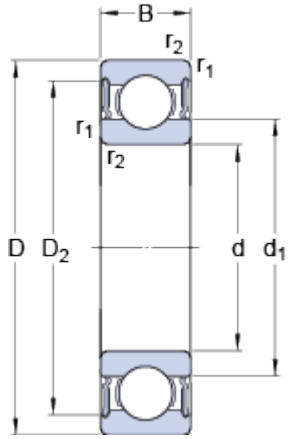

d	55	mm
D	90	mm
B	18	mm
d ₁	≈ 66.3	mm
D ₂	≈ 81.5	mm
r _{1,2}	min. 1.1	mm

Abutment dimensions

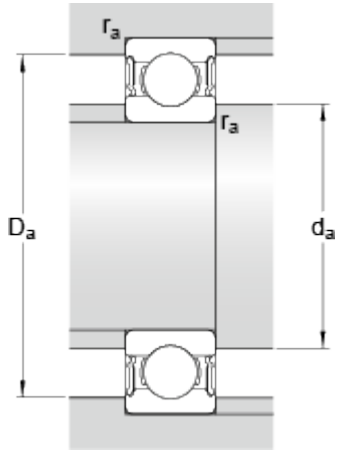

d _a	min. 61	mm
d _a	max. 66.2	mm
D _a	max. 84	mm
r _a	max. 1	mm

Calculation data

Basic dynamic load rating	C	29.6	kN
Basic static load rating	C ₀	21.2	kN
Fatigue load limit	P _u	0.9	kN
Limiting speed		4500	r/min
Calculation factor	k _r	0.025	
Calculation factor	f ₀	15.4	

Mass

Mass bearing		0.395	kg
--------------	--	-------	----