

6001-2Z

SKF Explorer

Dimensions

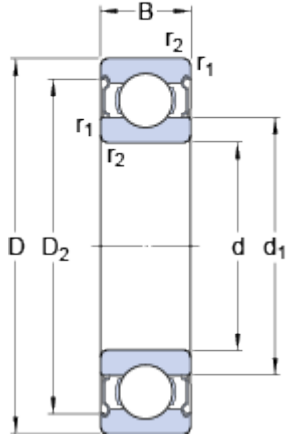

d	12	mm
D	28	mm
B	8	mm
d ₁	17	mm
D ₂	24.72	mm
r _{1,2}	min. 0.3	mm

Abutment dimensions

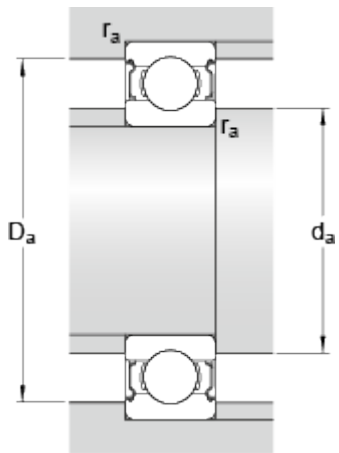

d _a	min. 14	mm
d _a	max. 16.9	mm
D _a	max. 26	mm
r _a	max. 0.3	mm

Calculation data

Basic dynamic load rating	C	5.4	kN
Basic static load rating	C ₀	2.4	kN
Fatigue load limit	P _u	0.1	kN
Reference speed		60000	r/min
Limiting speed		30000	r/min
Calculation factor	k _r	0.025	
Calculation factor	f ₀	13	

Mass

Mass bearing	0.0223	kg
--------------	--------	----

