

6301-2Z

SKF Explorer

Dimensions

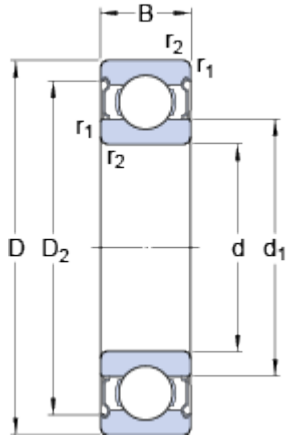

d	12	mm
D	37	mm
B	12	mm
d ₁	≈ 19.5	mm
D ₂	≈ 31.4	mm
r _{1,2}	min. 1	mm

Abutment dimensions

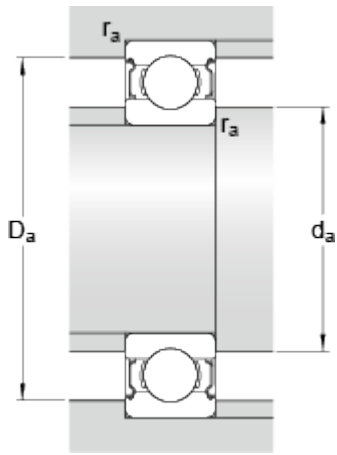

d _a	min. 17.6	mm
d _a	max. 19.4	mm
D _a	max. 31.4	mm
r _a	max. 1	mm

Calculation data

Basic dynamic load rating	C	10.1	kN
Basic static load rating	C ₀	4.1	kN
Fatigue load limit	P _u	0.17	kN
Reference speed		45000	r/min
Limiting speed		22000	r/min
Calculation factor	k _r	0.03	
Calculation factor	f ₀	11	

Mass

Mass bearing		0.0628	kg
--------------	--	--------	----