

6208-2RS1

SKF Explorer

Dimensions

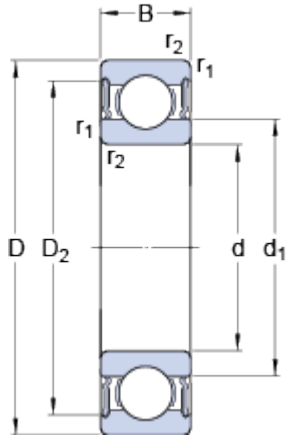

d	40	mm
D	80	mm
B	18	mm
d ₁	≈ 52.6	mm
D ₂	≈ 69.8	mm
r _{1,2}	min. 1.1	mm

Abutment dimensions

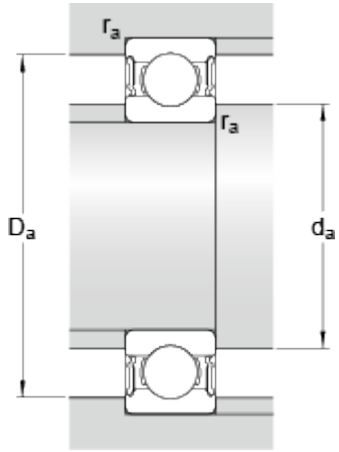

d _a	min. 47	mm
d _a	max. 52.5	mm
D _a	max. 73	mm
r _a	max. 1	mm

Calculation data

Basic dynamic load rating	C	32.5	kN
Basic static load rating	C ₀	19	kN
Fatigue load limit	P _u	0.8	kN
Limiting speed		5600	r/min
Calculation factor	k _r	0.025	
Calculation factor	f ₀	13.8	

Mass

Mass bearing		0.377	kg
--------------	--	-------	----