

# 6009-2RS1

SKF Explorer

## Dimensions

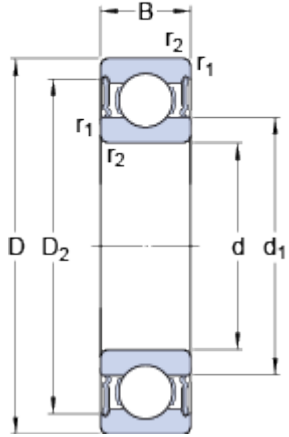

d	45	mm
D	75	mm
B	16	mm
d <sub>1</sub>	54.75	mm
D <sub>2</sub>	67.8	mm
r <sub>1,2</sub>	min. 1	mm

## Abutment dimensions

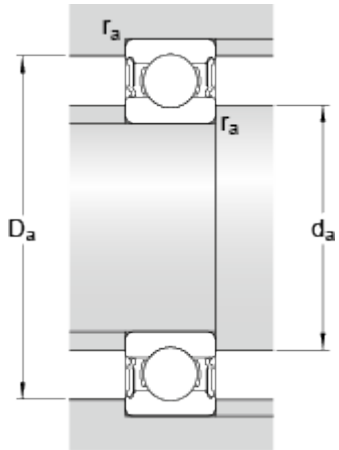

d <sub>a</sub>	min. 50.8	mm
d <sub>a</sub>	max. 54.7	mm
D <sub>a</sub>	max. 69.2	mm
r <sub>a</sub>	max. 1	mm

## Calculation data

Basic dynamic load rating	C	22.1	kN
Basic static load rating	C <sub>0</sub>	14.6	kN
Fatigue load limit	P <sub>u</sub>	0.64	kN
Limiting speed		5600	r/min
Calculation factor	k <sub>r</sub>	0.025	
Calculation factor	f <sub>0</sub>	14.9	

## Mass

Mass bearing		0.251	kg
--------------	--	-------	----